

---

# AUTOMATIC WATER FILTRATION

with High-Flow 1" Valve

Model AIF10

## **Automatic Iron and Hydrogen Sulfide Filter**

Installation

Operation

Maintenance

Repair Parts

Manufactured and warranted by  
Water Channel Partners  
1890 Woodlane Drive  
Woodbury, MN 55125

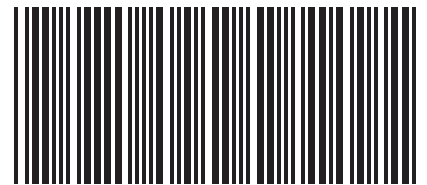

7320079 (Rev. S 3/26/20)

---

## TABLE OF CONTENTS

	<u>Page</u>
Inspect Shipment / Safety Guides . . . . .	3
Specifications & Dimensions . . . . .	4
Before Starting Installation . . . . .	5
Typical Installation Illustrations . . . . .	6
Installation Instructions . . . . .	7-9
Programming the Electronic Controller . . . . .	10-11
Customizing Features / Options . . . . .	12-14
Adding Potassium Permanganate Powder to Feeder Tank . . . . .	15
Cleaning the Nozzle & Venturi . . . . .	15
Troubleshooting . . . . .	16-19
Troubleshooting Guide . . . . .	16
Schematic . . . . .	17
Exploded View & Parts List . . . . .	20-23

### **WATER FILTER WARRANTY**

**Warrantor: Water Channel Partners, 1890 Woodlane Drive, Woodbury, MN 55125**

Warrantor guarantees, to the original owner, that:

**One Year Full Warranty:**

- For a period of one (1) year from the date of purchase, all parts will be free from defects in materials and workmanship and will perform their normal functions.

**Limited Warranties:**

- For a period of ten (10) years from the date of purchase, the fiberglass mineral tank, excluding mineral, will not rust, corrode, leak, burst, or in any other manner, fail to perform their proper functions.
- For a period of three (3) years from the date of purchase, the electronic control board and valve body will be free of defects in materials and workmanship and will perform their normal functions.

If, during such respective period, a part proves to be defective, Warrantor will ship a replacement part directly to your home, without charge.

**General Provisions**

Damage to any part of this water filter because of misuse, misapplication, neglect, alteration, accident, installation or operation contrary to our printed instructions, or damage caused by any unusual force of nature such as, but not limited to, freezing, flood, hurricane, tornado, or earthquake is not covered by this warranty. In all such cases, regular parts and service charges will apply.

We assume no warranty liability in connection with this water filter other than specified herein. This warranty is in lieu of all other warranties, expressed or implied, including warranties of fitness for a particular purpose. We do not authorize any person or representative to assume for us any other obligations on the sale of this water filter.

Should a defect or malfunction occur, contact your contractor. If you are unable to contact your contractor, return the part, freight prepaid, directly to the factory at the address below. Enclose with the part a full description of the problem, with your name, full address, date purchased, model and serial numbers, and selling contractor's name and address. We will repair or replace the part and return it to you at no cost if our repair department determines it to be defective under the terms of the warranty.

This warranty gives you specific legal rights and you may have other rights which vary from state to state.

This water filter is manufactured by  
Water Channel Partners, 1890 Woodlane Drive, Woodbury, MN 55125  
Customer Information Telephone No. 1-800-972-0136

---

# Inspect Shipment

The filter is shipped in one carton, including the potassium permanganate feeder assembly. The filter is completely assembled at the factory, except as required at installation. The filter's mineral tank is loaded with the proper quantity of manganese green-sand, gravel and sand.

Thoroughly check the filter system for possible shipping damage and parts loss. Also inspect and note any damage to the shipping carton.

Remove and discard (or recycle) all packing materials. To avoid loss of small parts, we suggest you keep the small parts in the parts bag until you are ready to use them.

## Safety Guides

Follow the installation instructions carefully. Failure to install the filter properly voids the warranty.

Before you begin installation, read this entire manual. Then obtain all the materials and tools you will need to make the installation.

**Check local plumbing and electrical codes.** The installation must conform to them.

**Use only lead-free solder and flux** for all sweat-solder connections as required by state and federal codes.

Use care when handling the filter. Do not turn upside down, drop, or set on sharp protrusions.

Do not locate the filter where freezing temperatures occur. **Do not attempt to filter water over 120°F.** Freezing, or hot water damage voids the warranty.

Avoid installing in direct sunlight. Excessive sun heat may cause distortion or other damage to non-metallic parts.

The filter requires a minimum water flow of 5 gallons per minute at the inlet for backwash.

Recommended **maximum allowable inlet water pressure is 80 psi.** Use a pressure reducing valve if necessary. Be sure the addition of a pressure reducing valve will not reduce the flow to less than the 5 gallons per minute needed for backwash.

The filter works on **24V DC** electrical power, supplied by a direct plug-in power supply (included). Be sure to use the included power supply, and plug it into a nominal **120V, 60 Hz** household outlet that is in a **dry location only**, grounded and properly protected by an overcurrent device such as circuit breaker or fuse.

This system is not intended to be used for treating water that is microbiologically unsafe or of unknown quality without adequate disinfection before or after the system.



European Directive 2002/96/EC requires all electrical and electronic equipment to be disposed of according to Waste Electrical and Electronic Equipment (WEEE) requirements. This directive or similar laws are in place nationally and can vary from region to region. Please refer to your state and local laws for proper disposal of this equipment.

# Specifications & Dimensions

	Automatic Iron Filter AIF10
Model Code	HIF10
Type of Mineral	Greensand Plus
Amount of Mineral	1.0 cu. ft.
Amount of Gravel Base	17 lbs.
Amount of Filter Sand	10 lbs.
Inlet Water Pressure Limits (min./max.)	40 - 125 psi
Nominal Mineral Tank Size	10" dia. x 47" tall
Water Temperature Limits (min./max.)	40 - 100 °F
Minimum Inlet Water Flow	7 gal./min.
Service Flow Rate*	2 - 5 gal./min.
Backwash Flow Rate	5 gal./min.
Inlet/Outlet Pipe Size	1"
Maximum Iron Removal	20 ppm
Supply Water Minimum pH	7
Capacity Rating	270 gal. with 10.6 ppm Hydrogen Sulfide (H <sub>2</sub> S) 620 gal. with 10.4 ppm Ferrous Iron (FeSO <sub>4</sub> ) 1900 gal. with 2.01 ppm Manganese (MnSO <sub>4</sub> )

\* Well pump must be able to provide the minimum flow for 30+ minutes.

Contaminant Removal	
Clear and/or Red Water Iron	Removes up to 15 ppm
Hydrogen Sulfide (rotten egg smell)	Removes up to 2 ppm
Manganese	Removes up to 5 ppm

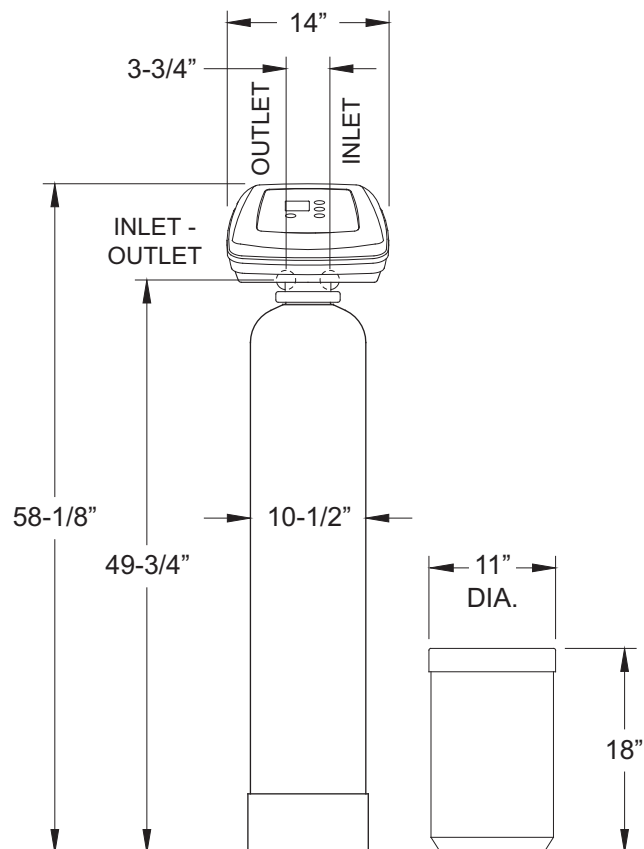

FIG. 1

---

# Before Starting Installation

## WHERE TO INSTALL THE FILTER

- Place the filter as close as possible to the pressure tank (well system) or water meter (city water).
- Place the filter as close as possible to a floor drain, or other acceptable drain point (laundry tub, sump, standpipe, etc.). The drain point must be able to discharge the backwash flow rates shown on page 3.
- Connect the filter to the main water supply pipe UPSTREAM OF the water heater. DO NOT RUN HOT WATER THROUGH THE FILTER. The temperature of water passing through the filter must be less than 120°F.
- Keep outside faucets on unfiltered water to conserve filtering capacity.
- Do not install the filter in a place where it could freeze. Damage caused by freezing is not covered by the warranty.
- Put the filter in a place water damage is least likely to occur if a leak develops. The manufacturer will not repair or pay for water damage.
- A 120V, 60 Hz electrical outlet, to plug the included power supply into, is needed near the filter. Be sure the electrical outlet and power supply are in an inside location, to protect from wet weather.
- If installing in an outside location, you must take the steps necessary to assure the filter, installation plumbing, wiring, etc., are as well protected from the elements, contamination, vandalism, etc., as when installed indoors.
- Keep the filter out of direct sunlight. The sun's heat may soften and distort plastic parts.

## TOOLS, PIPE & FITTINGS, OTHER MATERIALS YOU WILL NEED

- Plastic inlet and outlet fittings included with the filter allow water flow equivalent to 1 inch nominal pipe. To maintain full valve flow, 1" pipes to and from the filter fittings are recommended. Do not reduce the pipes to less than 3/4" size. Follow local codes.
- Use copper, brass, or galvanized pipe and fittings. Some codes may also allow CPVC plastic pipe.
- ALWAYS install the included bypass valve, or 3 shut-off valves. Bypass valves let you turn off water to the filter for repairs if needed, but still have water available to the house pipes.
- Drain hose, 5/8" inside diameter minimum, with a garden hose connection on one end, is needed for the valve drain. See step 5 on page 8.
- If a rigid valve drain is needed, to comply with plumbing codes, you can buy the parts needed (see page 6) to connect a 1/2" minimum copper tubing drain.
- Potassium permanganate is needed for regeneration of the filter mineral. It is available from most dealers of water conditioning equipment. This filter uses from 2 to 5 ounces of potassium permanganate each regeneration.

## PLAN HOW YOU WILL INSTALL THE FILTER

You must first decide how to run in and out pipes to the filter. Look at the house main water pipe at the point where you will connect the filter. Is the pipe soldered copper, glued plastic, or threaded brass/galvanized? What is the pipe size?

Now look at the typical installation illustration on page 6. Use it as a guide when planning your particular installation. Be sure to direct incoming, unfiltered water to the filter valve inlet fitting. The valve ports are marked IN and OUT.

# Typical Installation Illustrations

## INSTALLATION USING INCLUDED BYPASS VALVE

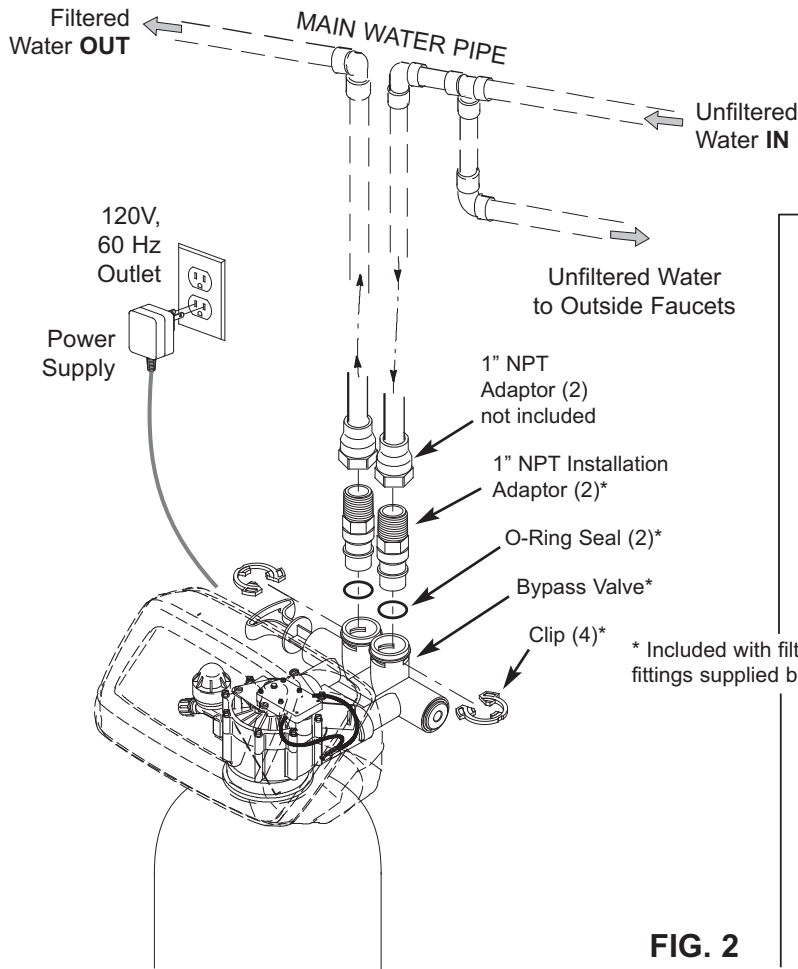
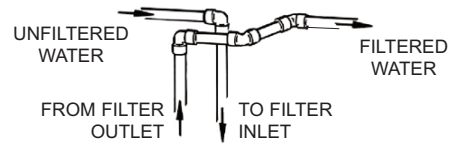

FIG. 2

## CROSS-OVER

Use if water supply flows from the left. Include single or 3-valve bypass.



## INSTALLATION USING 3-VALVE BYPASS

For filtered water SERVICE:

- Open the inlet and outlet valves

For unfiltered BYPASS:

- Close the inlet and outlet valves
- Open the bypass valve

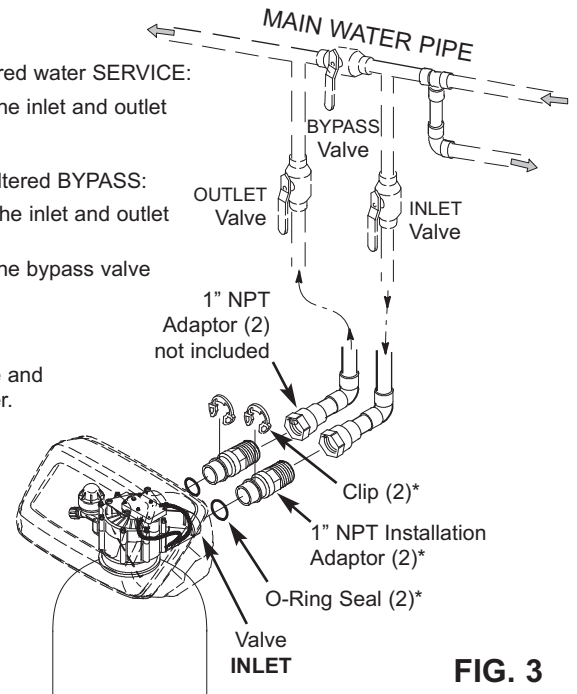
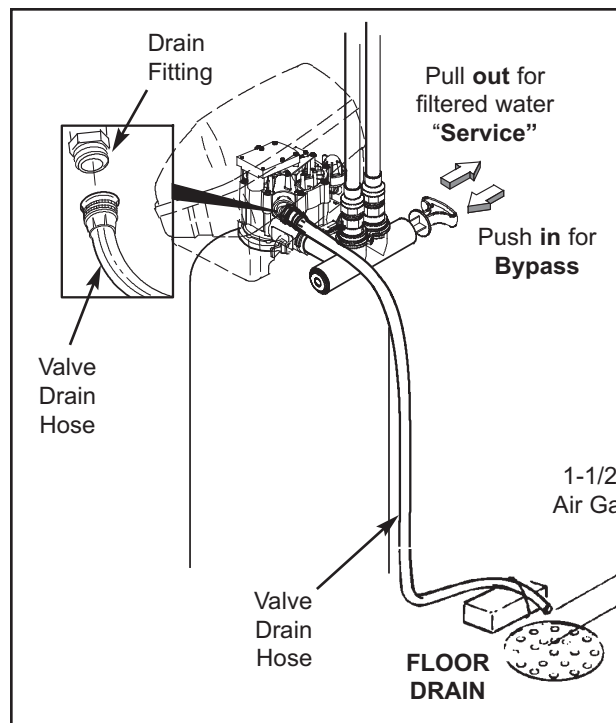
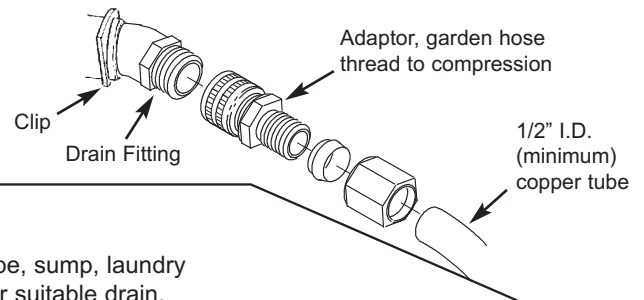

FIG. 3



## CONNECTING A RIGID VALVE DRAIN TUBE

To adapt a copper tube to the filter, buy a compression fitting (garden hose thread to 1/2" I.D. minimum tube and necessary tubing from your local hardware store.



To standpipe, sump, laundry tub or other suitable drain.

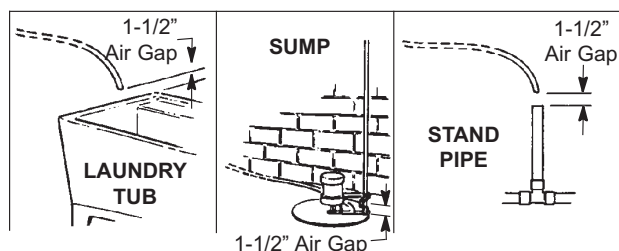

FIG. 4

# Installation Instructions

## IMPORTANT SANITIZING PROCEDURES

Care is taken at the factory to keep your water filter clean and sanitary. Materials used to make the filter will not infect or contaminate your water supply, and will not cause bacteria to form or grow. However, during shipping, storage, installing and operating, bacteria could get into the filter or media. For this reason, sanitizing as follows is suggested\* when installing.

a. Pour about 1 ounce of the following disinfectant into the valve inlet fitting:

- Calcium hypochlorite, available in granular or tablet form, under trade names such as Perchloron or HTH - **OR** -
- Common 5.25% household bleach (Clorox or other brands).

b. Complete the sanitizing procedures in steps 7 and 10, below.

**\*NOTE:** Sanitizing is recommended by the Water Quality Association for disinfecting. On some water supplies, they suggest periodic sanitizing.

## 1. TURN OFF WATER SUPPLY

- a. Close the main water supply valve near the well pump or water meter.
- b. Shut off the electric or fuel supply to the water heater.
- c. Open high and low faucets to drain all water from the house pipes.

## 2. INSTALL BYPASS VALVE AND/OR PLASTIC INSTALLATION ADAPTORS

a. If installing a single bypass valve, push the bypass valve, with lubricated o-ring seals in place, into the valve inlet and outlet ports (See Figures 2 & 5).

- OR -

b. If installing a 3-valve bypass system, slide plastic installation adaptors, with lubricated o-ring seals in place, into the valve inlet and outlet ports (See Figures 3 & 5).

c. Make sure the turbine support is in place in the valve outlet, as shown in Figure 6.

d. Snap the two large plastic clips in place on the inlet and outlet ports, from the top, down (See Figure 7). Be sure they snap into place. Pull on the bypass valve, or installation adaptors, to make sure they are held securely in place.

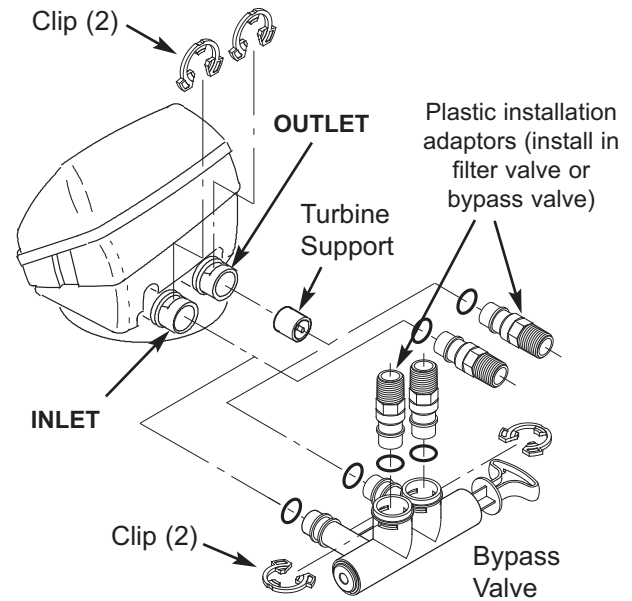

FIG. 5

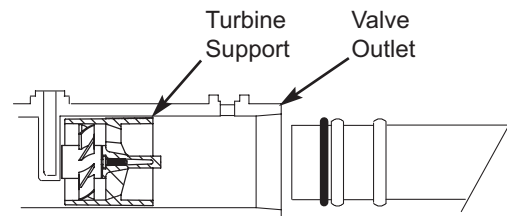

FIG. 6

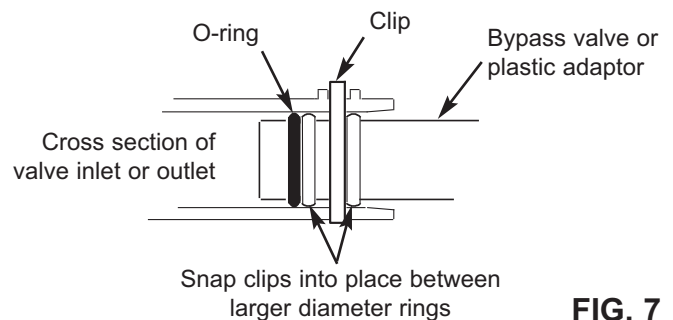

FIG. 7

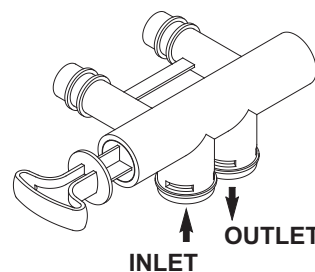

FIG. 8



# Installation Instructions

## 3. COMPLETE PLUMBING TO AND FROM THE FILTER

Using the “Typical Installation Illustrations” on page 6 as a guide, observe all of the following cautions while you connect inlet and outlet plumbing:

- Be sure incoming, **unfiltered water** is directed to the valve **INLET** port.
- Be sure to install bypass valve(s).
- If making a soldered copper installation, do all sweat soldering before connecting pipes to the filter fittings. Torch heat will damage plastic parts.
- Use pipe joint compound on all external pipe threads.
- When turning threaded pipe fittings onto plastic fittings, use care not to cross-thread.
- Support inlet and outlet plumbing in some manner (use pipe hangers) to keep the weight off of the valve fittings.

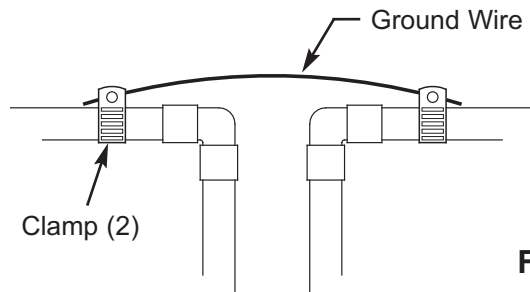

FIG. 9

## 4. COLD WATER PIPE GROUNDING

**CAUTION:** The house cold water pipe (metal only) is often used as a ground for the house electrical system. The 3-valve bypass type of installation, shown in Figure 3, will maintain ground continuity. If you use a plastic bypass valve at the unit, continuity is broken. To restore the ground, do the following:

- a. Install a #4 copper wire across the removed section of main water pipe, securely clamping it at both ends (See Figure 9) - parts not included.

**NOTE:** Check local plumbing and electrical codes for proper installation of grounding. The installation must conform to them. In Massachusetts, plumbing codes of Massachusetts shall be conformed to. Consult with your licensed plumber.

## 5. INSTALL VALVE DRAIN HOSE

- a. Take a length of 5/8" inside diameter garden hose and attach to the valve drain fitting (See Figure 4 on page 6).
- b. Locate the other end of the hose at a suitable drain point (floor drain, sump, laundry tub, etc.). Check and comply with local codes. Refer to Figure 4 on page 6 if codes require a rigid pipe drain run.

**IMPORTANT:** Use high quality, thick wall hose that will not easily kink or collapse. The filter will not backwash properly if water cannot exit this hose during recharges.

- c. Tie or wire the hose in place at the drain point. Water pressure will cause it to whip during the backwash and fast rinse cycles of recharge. Also provide an air gap of at least 1-1/2" between the end of the hose and the drain point. An air gap prevents possible siphoning of sewer water, into the filter, if the sewer should back up.
- d. If raising the drain hose overhead is required to get to the drain point, do not raise higher than 8 feet above the floor. Elevating the hose may cause a back pressure that could reduce backwash flow and proper mineral bed cleaning.

## 6. CONNECT THE POTASSIUM PERMANGANATE FEEDER

- a. Run the 5/16" tubing from the brine valve to the nozzle assembly on the filter (See Figure 10). Use slots in the tank and both brinewells to hold tubing in place.
- b. Attach a length of 3/8" or 7/16" I.D. drain hose (7 feet included) to the hose fitting on the tank side-wall. Place the outlet of the hose over the floor drain. This is a gravity drain, and must flow downward. Provide an air gap as you did with the valve drain hose.

**CAUTION:** Do not omit this hose. If the feeder tank should overflow, the drain hose carries excess potassium permanganate solution to the drain. This solution will deeply stain anything it contacts.

- c. With brinewell covers in place, pour the included 2 lbs. of potassium permanganate powder into the feeder tank, then about 1/2 gallon of water. Install the tank cover.



# Installation Instructions

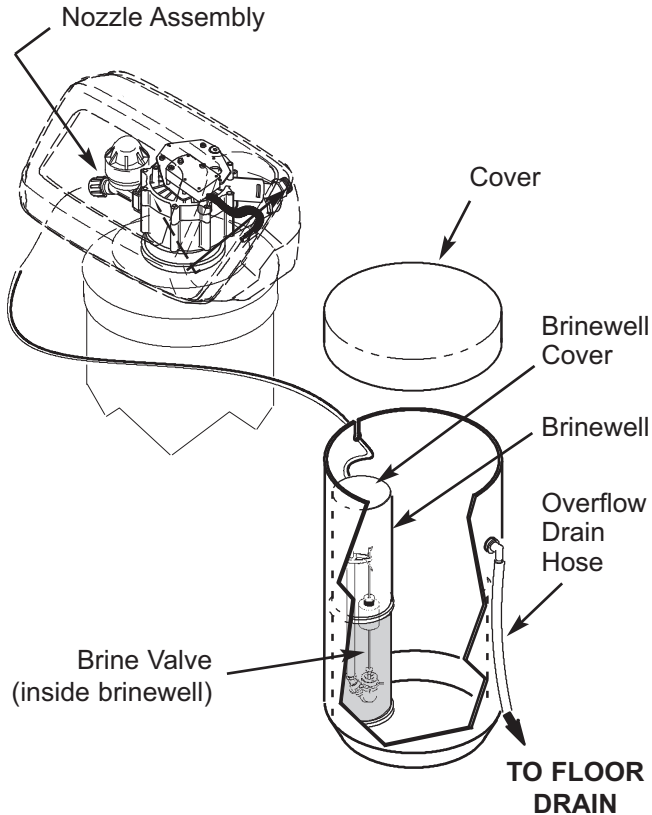

FIG. 10

## 7. FLUSH PIPES, CIRCULATE DISINFECTANT, EXPEL AIR FROM FILTER, AND TEST YOUR INSTALLATION FOR LEAKS

**CAUTION:** To avoid water or air pressure damage to filter inner parts, be sure to do the following steps exactly as listed:

- a. Fully open two cold, filtered water faucets nearby the filter.
- b. Place bypass valve(s) into "bypass" position. On a single valve, slide the stem inward to BYPASS (See Fig. 4 on page 6). On a 3 valve system, close the inlet and outlet valves, and open the bypass valve (See Fig. 3 on page 6).
- c. Fully open the house main water pipe shutoff valve. Observe a steady flow from both opened faucets.
- d. Place bypass valve(s) into "service", EXACTLY as follows. KEEP FILTERED WATER FAUCETS OPEN.
  - **Single Bypass Valve:** SLOWLY, pull the valve stem outward to "service" position, pausing several times to allow the filter to pressurize slowly.
  - **3 Valve Bypass:** Fully close the bypass valve and open the outlet valve. SLOWLY, open the inlet valve, pausing several times to allow the filter to pressurize slowly. The sanitizing bleach also circulates through the filter.
- e. After about three minutes, open a HOT water faucet for one minute, or until all air is expelled, then close.
- f. Close both cold water faucets.
- g. Check your plumbing work for leaks and, if any are found, fix right away. Be sure to observe previous caution notes.
- h. Turn on the gas or electric supply to the water heater. Light the pilot, if applicable.

## 8. CONNECT TO ELECTRICAL POWER

The filter works on low voltage electric power. The included power supply changes standard 120V AC house power to 24V DC. Plug the power supply into a 120V, 60 Hz electrical outlet. Be sure the outlet is always "live" so it can not be switched off by mistake.

## 9. PROGRAM THE TIMER

See pages 10 & 11 for instructions to program the timer.

## 10. CLEANING / SANITIZING PROCEDURE

- a. About 20 minutes after completing step 6, use the RECHARGE NOW feature, on the timer, to start an immediate recharge. Any remaining sanitizing bleach is drawn through the filter and discharged to the drain. The backwash and following fast rinse is over in about 40 minutes.
- b. After the recharge has completed, fully open a cold water faucet downstream from the filter and allow 50 gallons of water to pass through the filter. This should take 20 minutes. Close the faucet.
- c. Cleaning/sanitizing process is complete.

# Programming the Electronic Controller

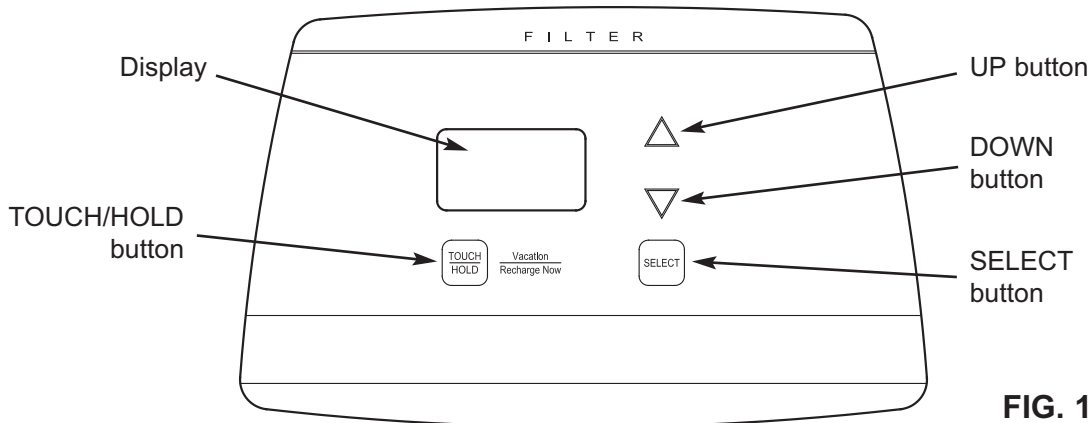

FIG. 11

## CONTROLLER SETTINGS REQUIRED

upon installation, and after an extended power outage.

When the power supply is plugged into the electrical outlet, a model code (HIF10) and a test number (example: J3.8), are briefly shown in the display. Then the words "PRESENT TIME" appear and 12:00 PM begins to flash.

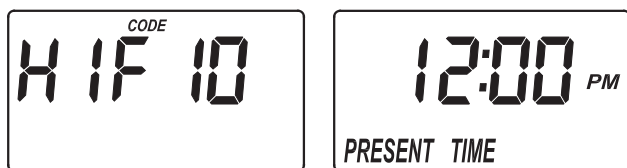

FIG. 12

## A. SET PRESENT TIME OF DAY

If the words "PRESENT TIME" do not show in the display, press the SELECT button several times until they do.

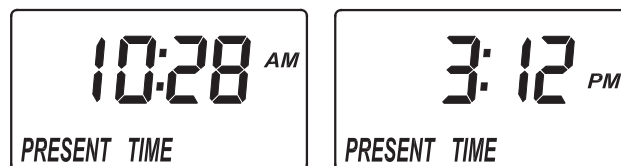

FIG. 13

1. Press the  $\triangle$  UP or  $\nabla$  DOWN buttons to set the present time. Up moves the display ahead; down sets the time back. Be sure AM or PM is correct.

**NOTE:** Press buttons and quickly release to slowly advance the display. Hold the buttons down for fast advance.

2. When the correct time is displayed, press the SELECT button, and the display will change to show the next setup screen.

# Programming the Electronic Controller

## B. SET DAYS BETWEEN RECHARGES

1. If you completed the previous step, the word "RECHARGE" should show in the display (See Figure 14). Otherwise, press the SELECT button several times until it does.

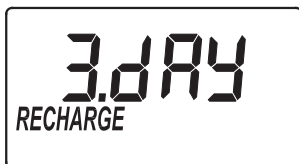

FIG. 14

2. The default setting is 3 days. This means that the filter will recharge every 3 days. See the chart below to determine the frequency of recharges. To change the number of days between recharges, use the  $\Delta$  UP or  $\nabla$  DOWN buttons to adjust from 1 to 99 days.
3. When the desired number of days is displayed, press the SELECT button, and the display will change to show the next setup screen.

### SUGGESTED DAYS BETWEEN RECHARGES

Number of People	Iron (parts per million)						
	2	4	6	8	10	15	20
1	7 days	6 days	5 days	4 days	3 days	3 days	2 days
2	6 days	5 days	3 days	3 days	2 days	1 day	1 day
3	5 days	3 days	2 days	2 days	1 day	1 day	1 day
4	4 days	3 days	2 days	1 day	1 day	1 day	1 day
5	4 days	2 days	1 day	1 day	1 day	1 day	1 day
6	3 days	2 days	1 day	1 day	1 day	1 day	1 day
7	3 days	1 day	1 day	1 day	1 day	1 day	1 day
8	2 days	1 day	1 day	1 day	1 day	1 day	1 day

**NOTE:** If there is an iron bleed or the water supply has high turbidity (sand, silt, sediments, etc.), set the filter to regenerate more often than the table above shows.

**NOTE:** In some extreme iron conditions, a fill setting of 2 minutes (3 ounces of potassium permanganate used), or 3 minutes (4 oz.) could be needed for each regeneration.

**NOTE:** If hydrogen sulfide is present, decrease the number of days between recharges by one or more (to a minimum setting of 1 day between recharges) until contaminant is removed.

## C. SET RECHARGE START TIME

1. If you completed the previous step, the words "RECHARGE TIME" should show in the display (See Figure 15). Otherwise, press the SELECT button several times until they do.



FIG. 15

2. The filter's default recharge start time is 12:00 AM. This is normally a time of day when water is not being used in the household. If you have a water softener or another filter installed, the recharge start times should be offset to assure adequate water flow and pressure. For example, if the water softener is set to begin recharge at 2:00 AM, set the filter to start recharge at 12:00 AM, or 4:00 AM. Use the  $\Delta$  UP or  $\nabla$  DOWN buttons to adjust the recharge start time.

3. When the desired recharge time is displayed, press the SELECT button, and the display will change to show the normal run (time of day) display.

---

# Controller Features / Options

## NORMAL OPERATION

During normal operation, the present time of day shows in the display.



FIG. 16

## POWER OUTAGE MEMORY

If electrical power to the filter's control is lost, internal memory will maintain most settings such as the days between recharge and recharge time. However, unless the power outage was very brief, the clock's present time will need to be reset. During a power outage, the display will be blank and the filter will not recharge. When electrical power is restored:

1. Check the display.
- 2a. If the present time is displayed steadily (not flashing), the controller did not lose time and you do not need to reset the clock.
- 2b. If a time is flashing in the display, then the clock needs to be reset to the correct present time. See "Set Time of Day" on page 10. The flashing display is to remind you to reset the clock. If you do not reset the clock, then recharges will most likely occur at the wrong time of day.

**NOTE:** If the filter was recharging when power was lost, it will finish the cycle when power returns.

## RECHARGE NOW

For times when you expect to use more water than usual, it may be desirable to perform a manually initiated recharge. To manually start a recharge cycle, press and hold the TOUCH/HOLD button for a few seconds, until "RECHARGE NOW" flashes in the display. The filter begins an immediate backwash. Once started, you cannot cancel this recharge. Avoid using hot water during this time, as the water heater will refill with unfiltered water.



FIG. 17

## VACATION CONTROL

1. **Before going on vacation**, or other long absence, press (but do not hold) the TOUCH/HOLD button, so that "VAC" begins to flash in the display. The timer continues to keep time, but recharges will not occur, saving water.



FIG. 18

2. **When you return**, press the TOUCH/HOLD button again. This cancels the flashing "VAC" and returns the filter to normal service. You must remember to do this, or the filter will not recharge.

# Controller Features / Options

## RECHARGE CYCLE TIME ADJUSTMENTS

The default durations for fill (0 minutes), solution draw / rinse (0 minutes), backwash (25 minutes), and fast rinse ( 5 minutes), are factory set for maximum filter performance. Use the following procedure to check for correct cycle times, or to change if desired.

However, only trained technicians should change the time settings.

### A. ADJUSTABLE FILL TIME

1. Press and hold for 3 seconds the SELECT button, until the display shows "000 - -" (See Figure 19), then press the SELECT button again to display the fill time adjust screen (See Figure 20).



FIG. 19



FIG. 20

2. Use the  $\triangle$  UP or  $\nabla$  DOWN buttons to adjust fill time from 0:00 minutes to 99:59 minutes.
3. When the desired fill time is displayed, press the SELECT button, and the display will change to show the next cycle time adjust screen.

### B. ADJUSTABLE SOLUTION DRAW / RINSE TIME

1. If you completed the previous step, the solution draw / rinse time adjust screen should show in the display (See Figure 21). Otherwise, press and hold for 3 seconds the SELECT button, until the display shows "000 - -", then press the SELECT button twice to display the solution draw / rinse time adjust screen.

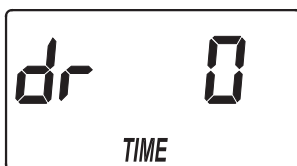

FIG. 21

2. Use the  $\triangle$  UP or  $\nabla$  DOWN buttons to adjust solution draw / rinse time from 0 to 255 minutes.
3. When the desired draw time is displayed, press the SELECT button, and the display will change to show the 12/24 hour clock setting screen.

### C. 12 OR 24 HOUR CLOCK

1. If you completed the previous step, the 12/24 hour clock setting screen should show in the display (See Figure 22). Otherwise, press and hold for 3 seconds the SELECT button, until the display shows "000 - -", then press the SELECT button three times to display the 12/24 hour clock setting screen.

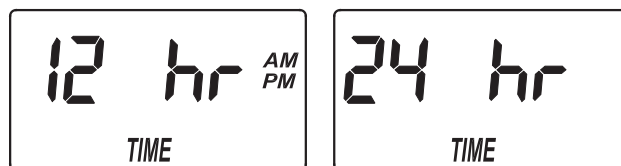

FIG. 22

2. All time displays are shown in 12 hour (AM/PM) format at the default setting. If 24 hour time format is desired, set to "24 hr" by pressing the  $\triangle$  UP button.
3. Press the SELECT button, and the display will change to show the next cycle time adjust screen.

### D. ADJUSTABLE BACKWASH TIME

1. If you completed the previous step, the backwash time adjust screen should show in the display (See Figure 23). Otherwise, press and hold for 3 seconds the SELECT button, until the display shows "000 - -", then press the SELECT button four times to display the backwash time adjust screen.

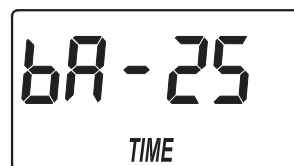

FIG. 23

2. Use the  $\triangle$  UP or  $\nabla$  DOWN buttons to adjust backwash time from 0 to 99 minutes.
3. When the desired backwash time is displayed, press the SELECT button, and the display will change to show the next cycle time adjust screen.

continued on next page

# Controller Features / Options

continued from previous page

## E. ADJUSTABLE FAST RINSE TIME

1. If you completed the previous step, the fast rinse time adjust screen should show in the display (See Figure 24). Otherwise, press and hold for 3 seconds the SELECT button, until the display shows "000 - -", then press the SELECT button five times to display the fast rinse time adjust screen.

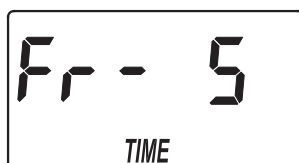

FIG. 24

2. Use the  $\triangle$  UP or  $\nabla$  DOWN buttons to adjust fast rinse time from 0 to 99 minutes.
3. When the desired fast rinse time is displayed, press the SELECT button. Press the SELECT button several times to advance through the remaining screens and return to the normal run (time of day) display.

## F. AUXILIARY OUTPUT CONTROL

The electronic controller's auxiliary output may be used to operate various types of external equipment, such as a chlorine generator or chemical feeder. It provides a 24V DC, up to 500 mA, current from terminal J4 on the electronic control board (see Schematic on page 17). The table below explains the choices available for when the auxiliary output will be on during various portions of the recharge cycle.

SELECTION	NAME	AUXILIARY OUTPUT FUNCTION
OFF	Off	Remains off indefinitely.
BP	Bypass	On during the entire recharge.
CL	Chlorine	On during the brine draw portion of the recharge.
FS	Flow Switch	On when water is flowing past the turbine*. It will shut off 8 seconds after water flow stops.
CF	Chemical Feeder	After the set volume of water has flowed past the turbine*, turns on for the time set (see Steps 4 & 5, below, to set volume and time).
FR	Fast Rinse	On during the fast rinse portion of the recharge.

The default is OFF. If you wish to change to one of the other selections shown in the table:

\* A turbine and turbine cable must be added to the system if auxiliary output selections "FS" or "CF" are to be used.

1. Press and hold the SELECT button until "000 - -" shows in the display (See Figure 25).

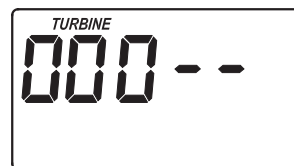

FIG. 25

2. Press the SELECT button six times, until "Ctrl" flashes in the display (See Figure 26).

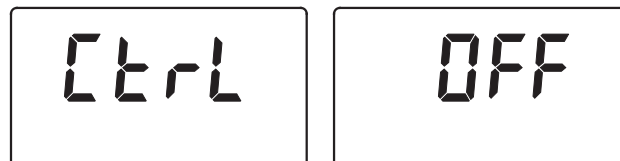

FIG. 26

3. Use the  $\triangle$  UP or  $\nabla$  DOWN buttons to display the desired selection, then press the SELECT button. If you selected anything other than CF, the display will return to the normal run (time of day) screen. If setting to CF (Chemical Feeder), there will be two additional settings to make for operating the chemical feeder in Steps 4 and 5, below.

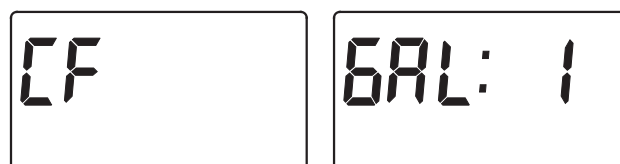

FIG. 27

4. **CHEMICAL FEEDER TRIP VOLUME:** If you have set the auxiliary output control to CF (Chemical Feeder), you will need to set the volume of water which must flow past the turbine\* before the auxiliary output is turned on. With the alternating screens in Fig. 27 shown, use the  $\triangle$  UP or  $\nabla$  DOWN buttons to set the trip volume, in gallons. Then press the SELECT button to display the screen shown in Fig. 28.

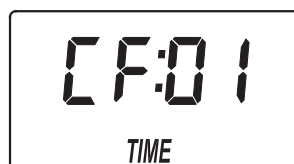

FIG. 28

5. **CHEMICAL FEEDER TIME:** Use the  $\triangle$  UP or  $\nabla$  DOWN buttons to set the length of time, in seconds, that the auxiliary output will be turned on. Then press the SELECT button to accept and return to the normal run (time of day) screen.



# General Filter Maintenance

## ADDING POTASSIUM PERMANGANATE POWDER TO FEEDER TANK

It is very important to always have some potassium permanganate powder in the feeder tank. If the filter goes too long without a regeneration with potassium permanganate, the filtering mineral will lose its manganese coating. Replacing the filter mineral bed can be costly. Be sure to check the feeder tank every 2-4 weeks, and stir the potassium permanganate powder to keep it from solidifying. Refill it with powder if less than an inch remains. After filling, check the tank overflow drain hose to be sure it is over the floor drain (see step 6, page 8).

## HOW LONG DOES THE POTASSIUM PERMANGANATE LAST?

Using 2 ounces of powder each regeneration (at 1 minute fill setting), 6 pounds of potassium permanganate powder will last for about 48 regenerations. Divide 48 by the number of regenerations needed each week. The answer is the approximate number of weeks the potassium permanganate should last. The 2 minute fill setting uses 3 ounces of powder, and 3 minutes uses 4 ounces.

NUMBER OF FULL WEEKS THAT 6 LBS. OF POTASSIUM PERMANGANATE POWDER LASTS			
Number of Regenerations Each Week	Fill Cycle Minutes		
	1	2	3
1	48	32	24
2	24	16	12
3	16	10	8
4	12	8	6
5	9	6	4
6	8	5	4
7	6	4	3

Note: The refill container has 6 pounds of potassium permanganate powder.

## CLEANING THE NOZZLE & VENTURI

A clean nozzle & venturi (Fig. 29) is needed for the filter to work properly. The nozzle & venturi creates the suction to move potassium permanganate solution from the feeder tank to the mineral tank during regeneration. It will not work if it becomes plugged with sand, silt, dirt, etc. The filter mineral will not be properly cleaned, and oxidizing capacity restored.

To get access to the nozzle & venturi, remove the filter's top cover. Make sure the filter is in "service" cycle (no water pressure at nozzle and venturi). Then, while holding the nozzle & venturi housing with one hand, unscrew the cap. Lift out the screen support and screen, then the nozzle and venturi. Wash and rinse the parts in warm water until clean. If needed, use a small brush to remove iron or dirt. Also check and clean the gasket.

Carefully put all parts back in place in the correct order. Be sure holes in gasket align with holes in the housing. Lubricate the o-ring seal with silicone grease and put in place. Install and tighten the cap, **BY HAND ONLY. DO NOT OVER-TIGHTEN AND BREAK THE CAP OR HOUSING.**

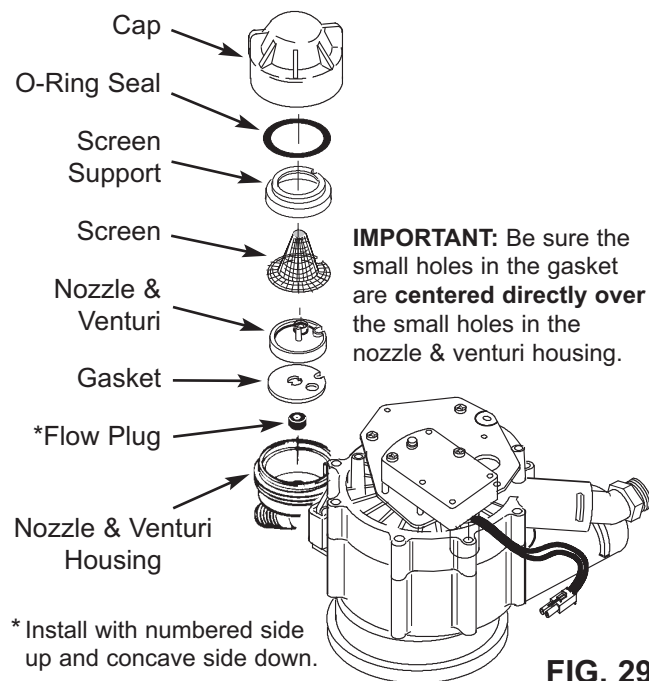

## PROTECT THE FILTER FROM FREEZING

If the filter is installed where it could freeze (summer cabin, lake home, etc.), you must drain all water from it to prevent possible freeze damage.



# Troubleshooting Guide

## CHECKLIST BEFORE YOU CALL FOR SERVICE

PROBLEM	CAUSE	CORRECTION
<b><i>Filter will not regenerate</i></b>	Manual plumbing bypass valve(s) in bypass position.	Refer to figures 3 and 4 on page 6, and position for filtered water "service".
	Power supply unplugged at wall outlet, fuse blown/circuit breaker popped, circuit switched off.	Check for loss of power and correct as needed. Reset the timer and use the RECHARGE NOW feature as described on page 12.
	Timer set for vacation (VAC).	Press the Touch/Hold button once to return the filter to service, see page 12.
	Timer not programmed for regenerations, or time too short.	See pages 11 or 13-14 to set.
	Error code shows in timer display.	See next page.
	Backwash flow control, drain hose restricted or plugged, backwash flow less than 5 gpm.	Check drain hose. Remove drain elbow on filter valve to check flow control. See page 22 to check for correct assembly and orientation. Backwash flow should be 5 gpm or higher.
	Nozzle assembly dirty.	Follow instructions on page 15 to clean.
<b><i>Low water pressure at house faucets</i></b>	Well pump pressure switch set too low.	Adjust to a minimum of 20 psi.
	More frequent regeneration needed to keep filter mineral clean.	See page 11 to set days between recharges.
<b><i>Filtered water contains iron, sediment, dirt, etc.</i></b>	See all conditions above.	
	Too infrequent regenerations programmed, or fill time setting too short.	See page 11 to set days between recharges, see page 13 to adjust fill time.
	Feeder tank out of potassium permanganate powder.	Follow instructions on page 15 to refill.
	Hot water used while filter regenerating.	The water heater will refill with unfiltered bypass water. See page 11 to set recharge start time.
	Possible increase in supply water iron content (common with some well water supplies).	Obtain a new water analysis and adjust the regeneration schedule and/or fill cycle time.
	Leaking faucet or toilet valve.	A small leak can waste hundreds of gallons of water in a few days time. Fix all plumbing leaks and always fully close faucets.

# Schematic

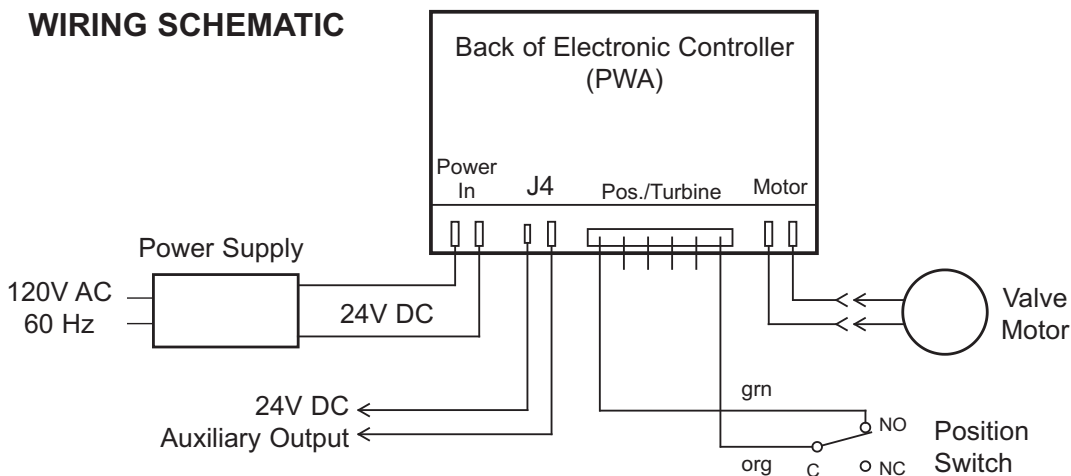
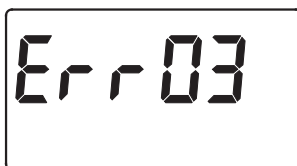

**FIG. 30**

## Troubleshooting

### AUTOMATIC ELECTRONIC DIAGNOSTICS

This filter has a self-diagnostic function for the electrical system. The computer monitors electronic components and circuits for correct operation. If a malfunction occurs, an error code appears in the display.



**FIG. 31**

Code	Possible Problems
Err01	Motor, Valve Position Switch
Err03	Motor, Valve Position Switch, Wire Harness
Err04	Valve Position Switch
Err05	Electronic Control Board (PWA)

The chart above shows the error codes that could appear, and the possible malfunctions for each code.

While an error code appears in the display, all buttons are inoperable except the SELECT button. SELECT remains operational so the service person can perform the Manual Initiated Electronic Diagnostics, see below, to further isolate the problem.

### TO REMOVE AN ERROR CODE:

1. Unplug the power supply.
2. Correct the problem.
3. Plug the power supply back in.
4. Wait for at least 8 minutes while the timer operates the valve through an entire cycle. The error code will return if the problem was not corrected.

### RESETTING TO FACTORY DEFAULTS

To reset the electronic controller to its factory default for all settings (time, days between recharges, etc.):

1. Press the SELECT button and hold it until the display changes twice to show "CODE" and the flashing model code.
2. Press the  $\Delta$  UP button (a few times, if necessary) to display a flashing "SoS".

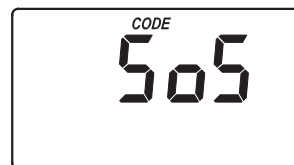

**FIG. 32**

3. Press the SELECT button, and the electronic controller will restart.
4. Set the present time, days between recharges, etc., as described on pages 10 & 11.

# Troubleshooting

## MANUALLY INITIATED ELECTRONIC DIAGNOSTICS

Use the following procedures to advance the filter through the recharge cycles to check operation.

Remove the top cover faceplate assembly by unlocking the tabs and lifting, to observe cam and switch operation during valve rotation (See Figure 34).

1. Press and hold for 3 seconds the SELECT button, until one of the screens shown in Figure 33 is displayed. If the valve is in service, fill, solution draw / brining, backwash or fast rinse position (observe markings on the valve cam), the display should show "000 - -", meaning the position switch is open. When the valve is moving, the display should show "000 - P", meaning that the position switch is closed.

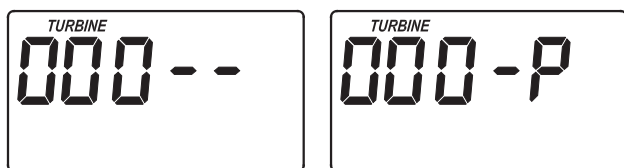

FIG. 33

### 2. Only for filter systems modified by adding a turbine and turbine cable:

If a turbine has been installed in your filter's valve outlet port, the first 3 digits of the display in Figure 33 should count upward whenever water is flowing through the system.

3. Use the TOUCH/HOLD button to manually advance the valve into each position and check correct switch operation.
4. While in this diagnostic screen, the following information is available and may be beneficial for various reasons. This information is retained by the

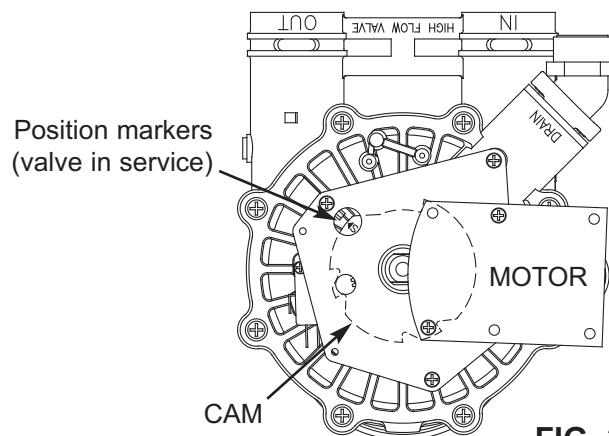

FIG. 34

computer from the first time electrical power is applied to the electronic controller.

- a. Press the  $\triangle$  UP button to display the number of days this electronic control has had electrical power applied.
  - b. Press the  $\nabla$  DOWN button to display the number of recharges initiated by this electronic control since the model code number was entered.
5. Press the SELECT button and hold in for 3 seconds until the model code shows in the display. This code identifies the filter model. If the wrong number shows (see table on page 4), the filter will operate on incorrect configuration data.
  6. To change the code number - Press the  $\triangle$  UP or  $\nabla$  DOWN button until the correct code shows.
  7. To return to the present time display, press the SELECT button. **If the model code was changed, make all timer settings.**

**NOTE:** If the electronic control is left in a diagnostic display (or a flashing display when setting times or hardness), present time automatically returns if a button is not pressed within 4 minutes.

# Troubleshooting

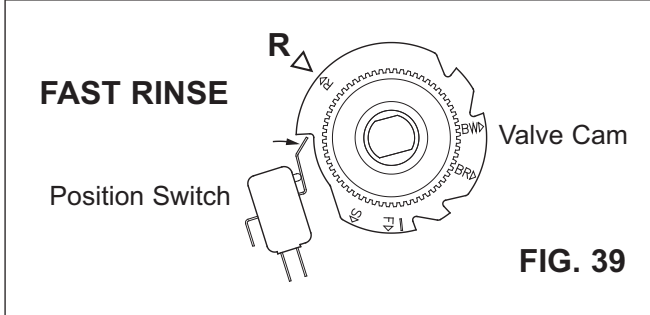
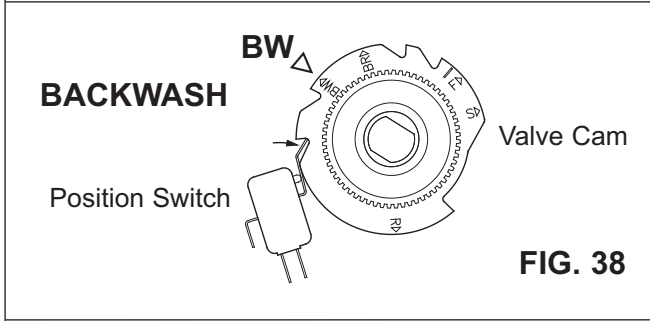
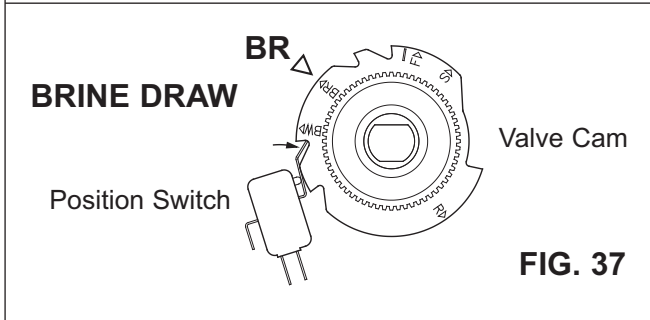
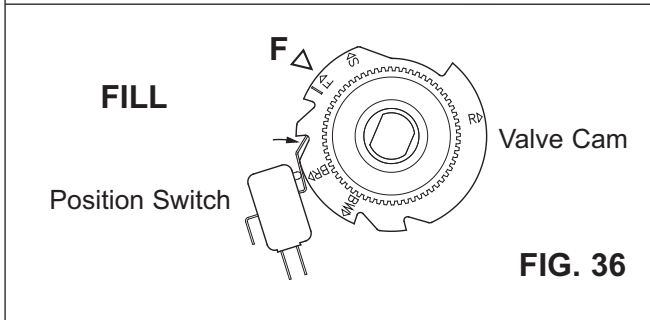
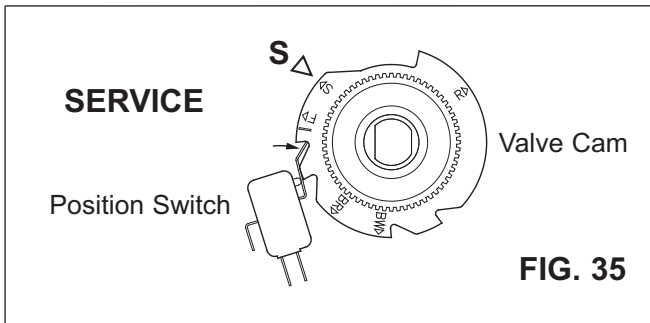

# Filter Assembly Parts

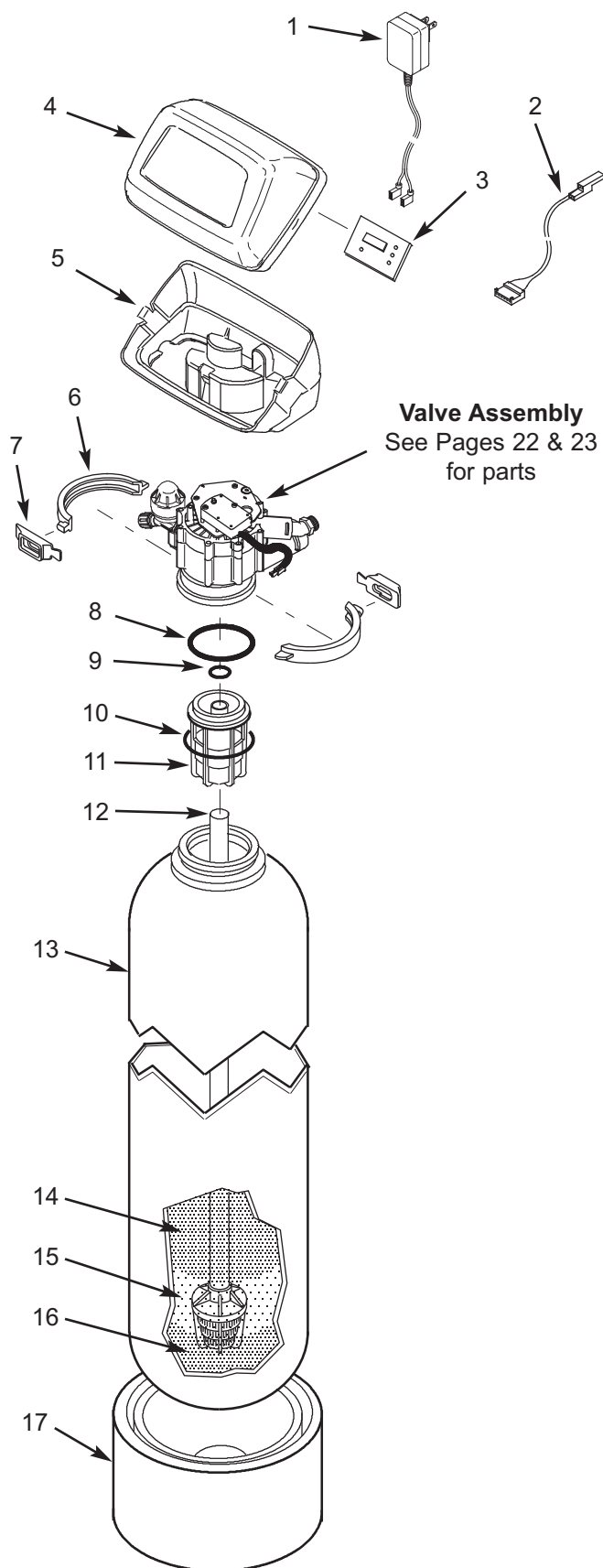

Key No.	Part No.	Description
1	7351054	Power Supply, 24V DC
2	7259927	Wire Harness
3	7366677	Repl. Timer (PWA)
4	7260554	Top Cover (order decal below)
■	7285279	Decal, Filter
5	7189449	Bottom Cover
-	7331177	Tank Neck Clamp Kit (includes Key Nos. 6 & 7)
6	↑	Clamp Section (2 req.)
7	↑	Retainer Clip (2 req.)
-	7112963	Distributor O-Ring Kit (includes Key Nos. 8-10)
8	↑	O-Ring, 2-7/8" x 3-1/4"
9	↑	O-Ring, 13/16" x 1-1/16"
10	↑	O-Ring, 2-3/4" x 3"
11	7088855	Top Distributor
12	7105047	Repl. Bottom Distributor
13	7092202	Mineral Tank, 10" x 47"
14	7331680	Greensand Plus, 1 cu. ft.
15	0501783	Filter Sand, 10 lbs.
16	7124415	Gravel, 17 lbs.
17	7302039	Tank Foot, 10" Tank

■ Not illustrated.

Manufactured and warranted by  
Water Channel Partners  
1890 Woodlane Drive  
Woodbury, MN 55125

# Feeder Assembly Parts

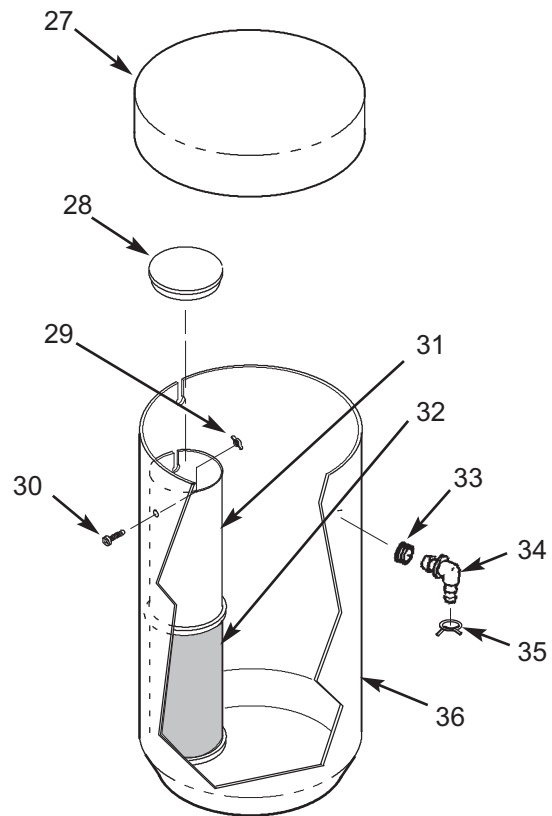
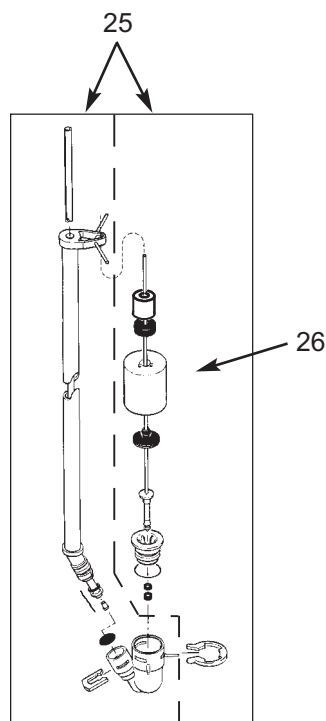

Key No.	Part No.	Description
25	7310155	Brine Valve Assembly
26	7289710	Float, Stem & Guide Assembly
27	7071133	Feeder Tank Cover
28	0500283	Cover, Brinewell
–	7331648	Brinewell Mounting Hardware Kit (includes Key Nos. 29 & 30)
29	↑	Wing Nut, 1/4-20
30	↑	Screw, 1/4-20 x 15.9 mm
31	7326928	Brinewell
32	7182390	Screen, Brinewell

Key No.	Part No.	Description
–	7331258	Overflow Hose Adaptor Kit (includes Key Nos. 33-35)
33	↑	Grommet
34	↑	Drain Hose Adaptor
35	↑	Hose Clamp
36	7182421	Feeder Tank
■	7161807	Drain Tubing, 5/16" x 20 ft.
■	7161768	Drain Tubing, 5/16" x 100 ft.
■	7317424	Potassium Permanganate Powder, 2 lbs.

■ Not illustrated.

# Valve Exploded View

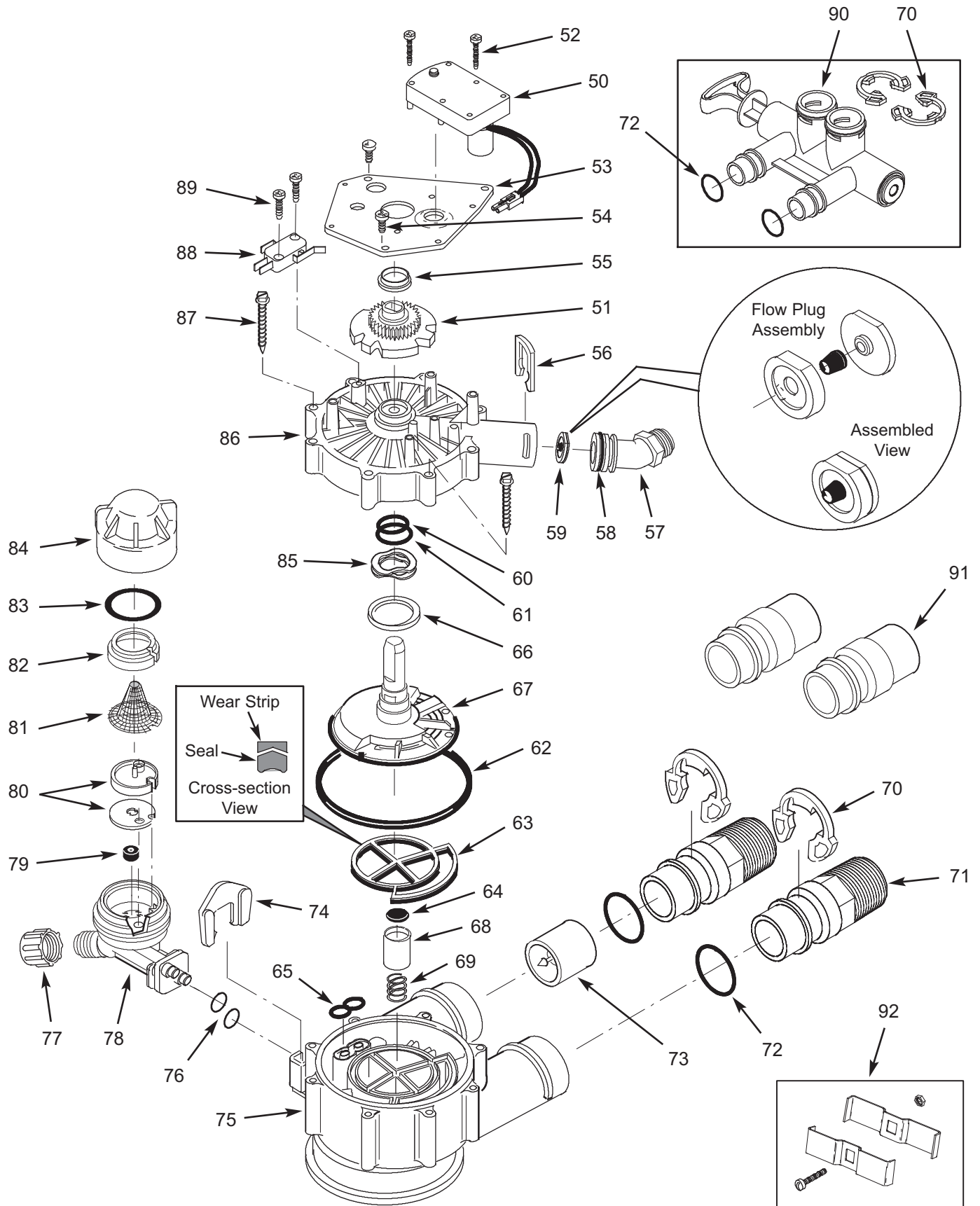



# Valve Parts List

Key No.	Part No.	Description
-	7384691	Motor, Cam & Gear Kit, 1" (includes Key Nos. 50-52)
50	↑	Motor
51	↑	Cam & Gear
52	7224087	Screw, #8-32 x 1" (2 req.)
53	7231393	Motor Plate
54	0900857	Screw, #6-20 x 3/8" (3 req.)
55	7171250	Bearing
-	7331711	Drain Hose Adaptor Kit (includes Key Nos. 56-59)
56	↑	Clip, Drain
57	↑	Drain Hose Adaptor
58	↑	O-Ring, 15/16" x 1-3/16"
59	↑	Flow Plug, 5.0 gpm
-	7185487	Seal Kit (includes Key Nos. 60-65)
60	↑	O-Ring, 5/8" x 13/16"
61	↑	O-Ring, 1-1/8" x 1-1/2"
62	↑	O-Ring, 4-1/2" x 4-7/8"
63	↑	Rotor Seal
64	↑	Seal
65	↑	Seal, Nozzle & Venturi
66	7174313	Bearing, Wave Washer
67	7185500	Rotor & Disc
-	7342712	Drain Plug Kit, 1" (includes Key Nos. 64, 68 & 69)
68	↑	Plug, Drain Seal
69	↑	Spring
70	7089306	Clip, 1", single (2 req.)
	7336428	Clip, 1", pack of 20
71	7271204	Installation Adaptor, 1", single
	7336614	Installation Adaptor, 1", pack of 10

Key No.	Part No.	Description
72	7311127	O-Ring, 1-1/16" x 1-5/16", single (2 req.)
	7336410	O-Ring, 1-1/16" x 1-5/16", pack of 20
73	7078240	Support
74	7081201	Retainer
75	7171145	Valve Body
76	7342649	O-Ring, 1/4" x 3/8", pack of 2
77	1202600	Nut - Ferrule
-	7085247	Nozzle & Venturi Assembly (includes Key Nos. 78-84)
78	7081104	Housing, Nozzle & Venturi
79	1148800	Flow Plug, .3 gpm
80	7114533	Nozzle & Venturi Kit w/Gasket
	7204362	Gasket only, single
	7336486	Gasket only, pack of 20
81	7146043	Screen
82	7167659	Screen Support
83	7170262	O-Ring, 1-1/8" x 1-3/8", single
	7336436	O-Ring, 1-1/8" x 1-3/8", pack of 20
84	7199729	Cap
85	7175199	Wave Washer
86	7171161	Valve Cover
87	7342681	Screw, #10 x 2-5/8", pack of 8
88	7305150	Switch
89	7140738	Screw, #4-24 x 3/4" (2 req.)
90	7214383	Bypass Valve Assembly, 1", including 2 ea. Clips & O-Rings (See Key Nos. 70 & 72)
91	7104546	Adaptor, PVC (2 req.) *
92	7248706	Ground Clamp Kit *

\* Not included with the system.

Manufactured and warranted by  
Water Channel Partners  
1890 Woodlane Drive  
Woodbury, MN 55125